

Arc ITB05

Bluetooth Balanced Output Decoding Upgrade Cable

Manual

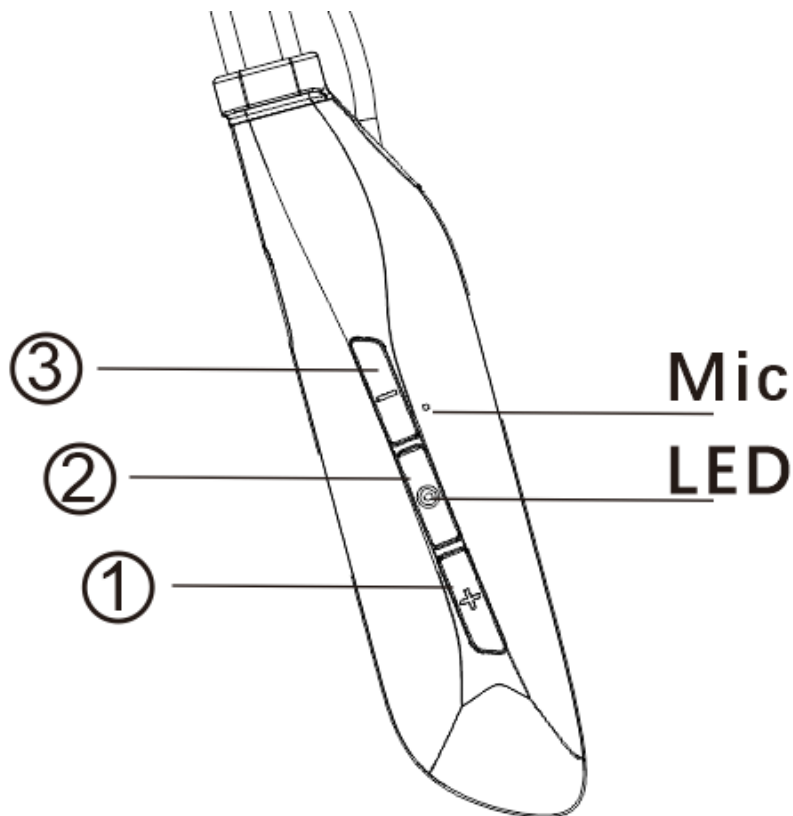



Buttons and interfaces

1.Buttons and Functions

Bluetooth pairing	In the off state, long press the key 2 for 5 seconds, until the red and blue light flashes
Power On	In the off state, press and hold the key 2 for 1 seconds
Power off	Long press the key 2 for 3 seconds in the power on state
Play / Tentative	Click the key 2
Activate voice assistant	Double-click on key 2
Call / hang up	Click key 2 when calling
Volume adjustment	Click key 1 to increase volume; click key 3 to decrease volume
Track switching	Long press key 1 for next song; long press key 3 for previous song

* When powering on, if it has not entered the pairing state, the last device is automatically connected. After the connection fails, enter the pairing state.

* If you want to connect the connected device on the Bluetooth side, you must press and hold the power button for about 5 seconds in the off state, until the red and blue lights flash, and enter the pairing state before you can connect other devices.

* If the device is already connected, connect Bluetooth from the device side, and then turn on Bluetooth. Bluetooth cannot automatically connect back, and the device side need be connected manually.

Interface:

1.TypeC charging interface

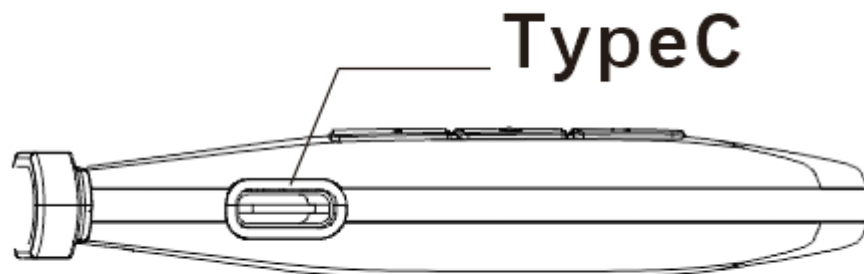

2. 0.78 2Pin

* the positive and negative poles are distinguished by the left and right mark surfaces

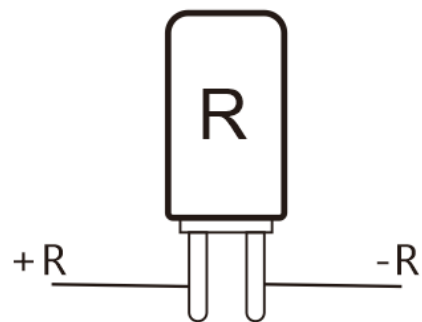
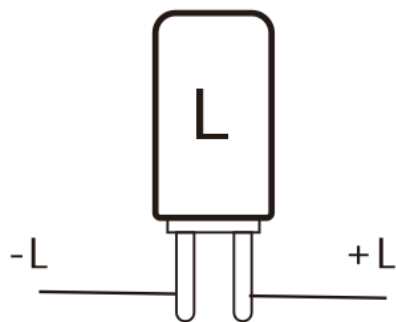

3. mmcX

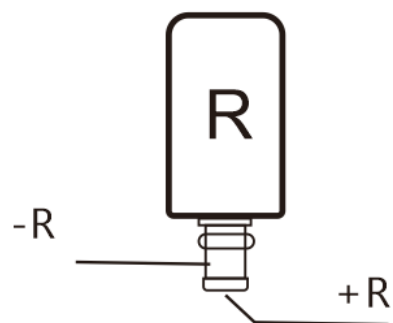
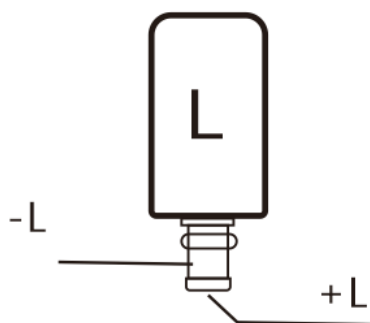

Specification:

1. Charging input: 5V 500ma
2. Audio output: the highest level output is 2.0v
- 3.SNR: 120dB
- 4.TNR: 0.001%
5. Battery capacity:> 280mAh
6. Working time: 9 hours
7. Supported formats: SBC; AAC; aptX;aptX-HD
- 8.BT version: 5.0

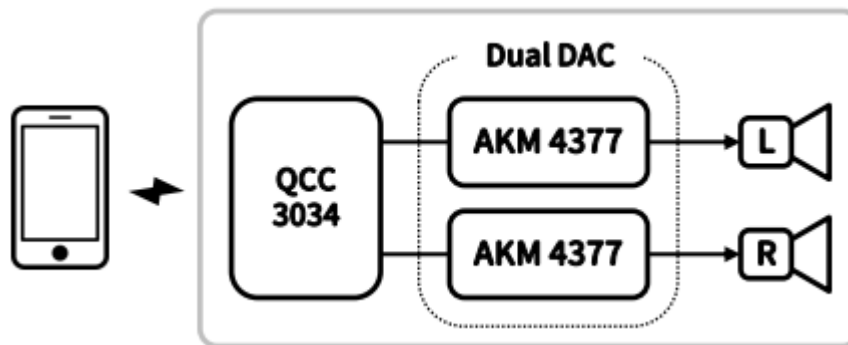

Package Include:

- 1.ITB05 * 1
- 2.Charging cable * 1
- 3.Instruction manual * 1
- 4.Warranty card * 1
- 5.Storage bag * 1

Arc ITB05

蓝牙平衡输出解码升级线

说明书

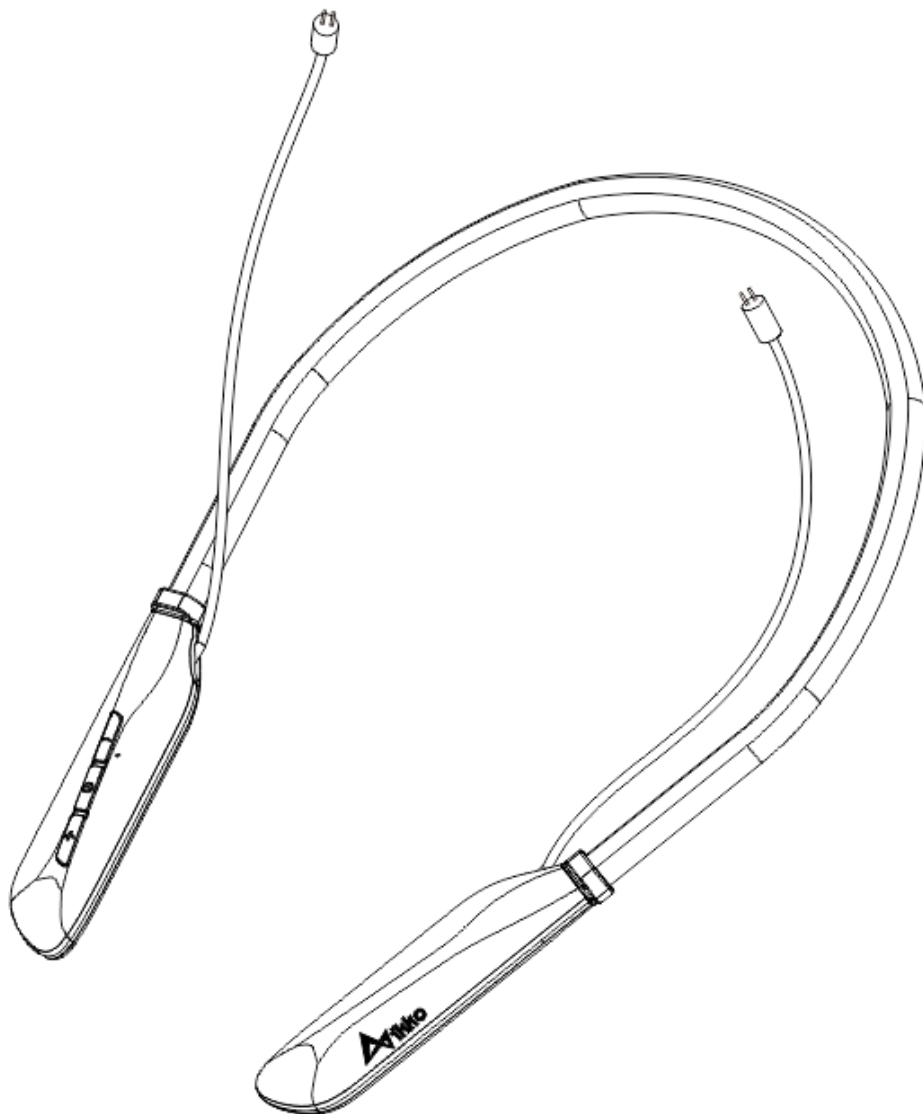

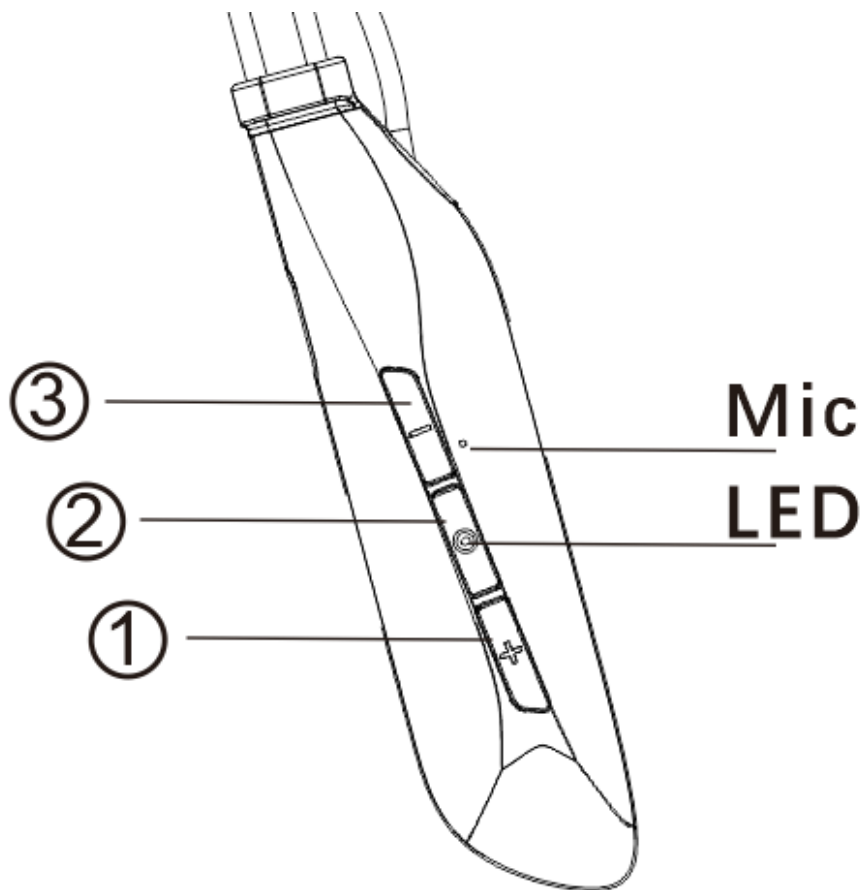

按键与接口

1. 按键及功能

配对	关机状态下长按 2 号键约 5 秒，至红蓝光闪烁
开机	关机状态下长按 2 号键约 1 秒
关机	开机状态下长按 2 号键约 3 秒
播放/暂定	单击 2 号键
激活语音助手	双击 2 号键
通话/挂断	来电时单击 2 号键
音量调节	单击 1 号键增加音量；单击 3 号键减少音量
曲目切换	长按 1 号键下一曲；长按 3 号键上一曲

*开机时候，如果没有进入配对状态，自动连接上次的设备。连接失败后，进入配对状态。

*如果要在蓝牙端断开已经连接的设备，必须要在关机状态下长按开机键约 5 秒，至红蓝光闪烁，进入配对状态才可以连接其他设备。

*如果设备在已经连接状态，从设备端断开蓝牙，再开启蓝牙，蓝牙不能自动回连，须设备端手动连接。

2.接口:

1.TypeC 充电接口

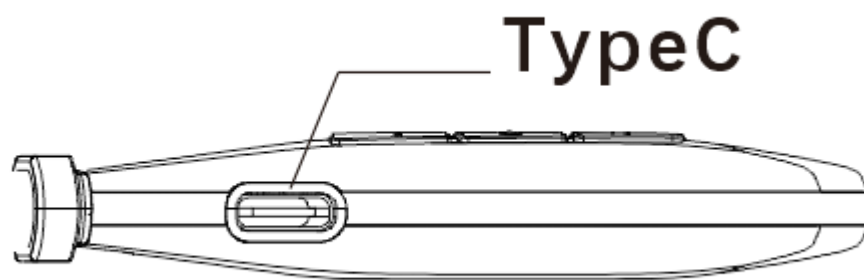

2. 0.78 2Pin

*以左右标记面区分正负极

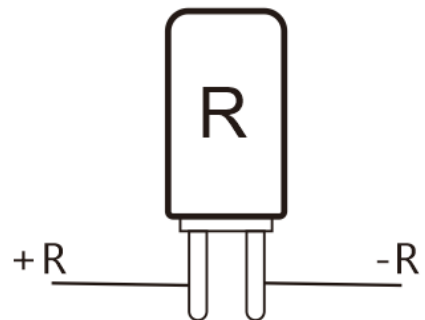
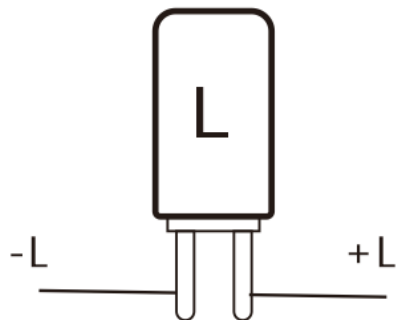

3. mmcX

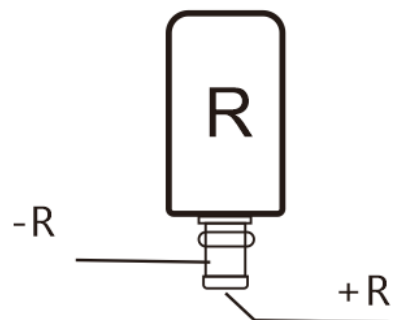
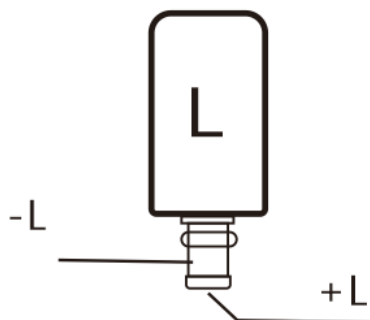

工作参数:

1. 充电输入: 5V 500ma
2. 音频输出: 最高电平输出 2.0v
3. SNR:120dB
4. TNR:0.001%
5. 电池容量: >280mAh
6. 工作时间: 9 小时
7. 支持格式: SBC; AAC; aptX; aptX-HD
8. BT 版本: 5.0

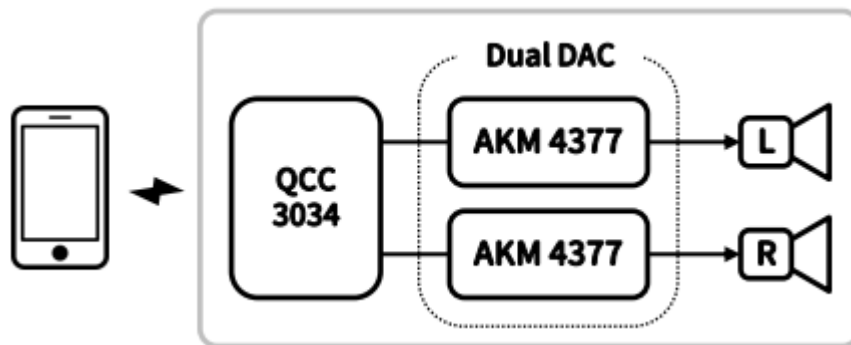

包装内容:

1. ITB05 *1
2. 充电线*1
3. 说明书*1
4. 保修卡*1
5. 收纳袋*1